

Operating Instructions

Color Video Monitor

Model No. **CT-2785Y**

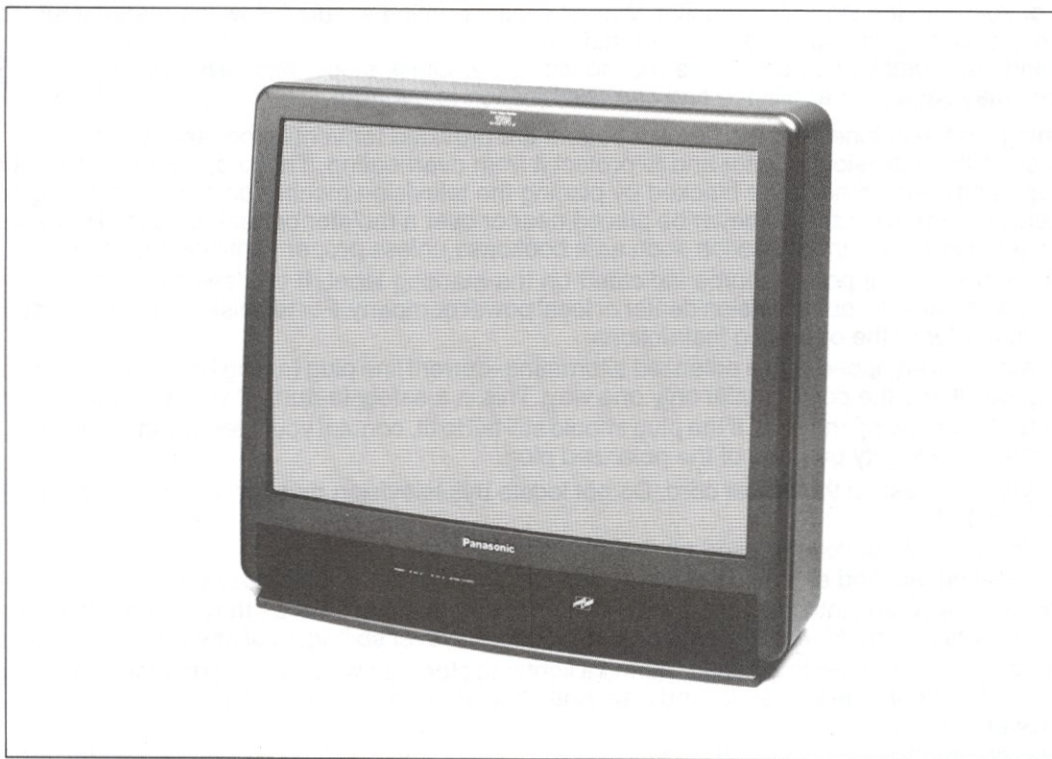

Panasonic®

Read these instructions completely before operating this unit.
Contents subject to change without notice or obligation.

Safety Instructions

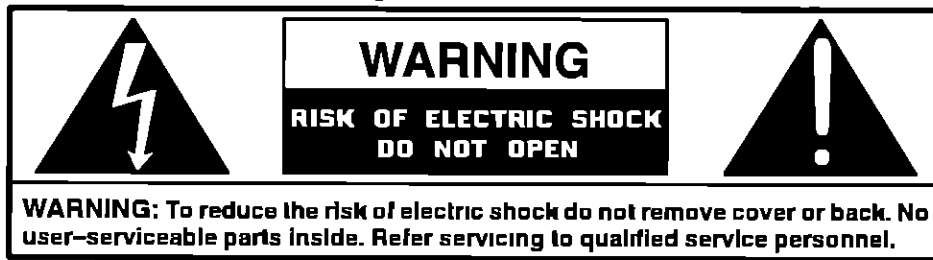

The lightning flash with arrow-head within a triangle is intended to tell the user that parts inside the product are a risk of electric shock to persons



The exclamation point within a triangle is intended to tell the user that important operating and servicing instructions are in the papers with the appliance

Safety Instructions for Television Monitors

- 1 Read and apply the operating instructions provided with your television monitor
- 2 Read all of the instructions given here and retain them for later use
- 3 Unplug this television monitor from the wall outlet before cleaning. Do not use liquid or aerosol cleaners. Use a damp cloth for cleaning.
- 4 Do not use attachments not recommended by the television monitor manufacturer as they may cause hazards
- 5 Do not use this television monitor near water. For example, avoid placing it near a bathtub, washbowl, kitchen sink, or laundry tub, in a wet basement, or near a swimming pool, etc.
- 6 Do not place this television monitor on an unstable cart, stand, or table. The television monitor may fall, causing serious injury to a child or adult, and serious damage to the appliance. Use only with a cart or stand recommended by the manufacturer, or sold with the television monitor. Wall or shelf mounting should follow the manufacturer's instructions, and should use a mounting kit approved by the manufacturer.
- 6A An appliance and cart combination should be moved with care. Quick stops, excessive force, and uneven surfaces may cause the appliance and cart combination to overturn.
- 7 Slots and openings in the cabinet and the back or bottom are provided for ventilation, and to insure reliable operation of the television monitor and to protect it from overheating. These openings must not be blocked or covered. The openings should never be blocked by placing the television monitor on a bed, sofa, rug or other similar surface. This television monitor should never be placed near or over a radiator or heat register. This television monitor should not be placed in a built-in installation such as a bookcase unless proper ventilation is provided.
- 8 Operate only from the type of power source indicated on the marking label. If you are not sure of the type of power supplied to your home consult your television dealer or local power company. For television monitors designed to operate from battery power, refer to the operating instructions.
- 9 This television monitor is equipped with a polarized alternating-current line plug (a plug having one blade wider than the other). This plug will fit into the power outlet only one way. This is a safety feature. If you are unable to insert the plug fully into the outlet, try reversing the plug. If the plug should still fail to fit, contact your electrician to replace your obsolete outlet. Do not defeat the safety purpose of the polarized plug.
- 10 Do not allow anything to rest on the power cord. Do not locate this television monitor where the cord will be abused by persons walking on it.
- 11 Follow all warnings and instructions marked on the television monitor.
- 12 Do not overload wall outlets and extension cords as this can result in fire or electric shock.
- 13 Never push objects of any kind into this television monitor through cabinet slots as they may touch dangerous voltage points or short out parts that could result in a fire or electric shock. Never spill liquid of any kind on the television monitor.
- 14 For added protection for this television monitor during a lightning storm, or when it is left unattended and unused for long periods of time, unplug it from the wall outlet and disconnect the antenna. This will prevent damage to the monitor due to lightning and power-line surges.
- 15 Unplug this television monitor from the wall outlet, and refer servicing to qualified service personnel under the following conditions:
 - a When the power cord or plug is damaged or frayed
 - b If liquid has been spilled into the television monitor
 - c If the television monitor has been exposed to rain or water
 - d If the television monitor does not operate normally by following the operating instructions. Adjust only those controls that are covered by the operating instructions as improper adjustment of other controls may result in damage and will often require extensive work by a qualified technician to restore the television monitor to normal operation.
 - e If the television monitor has been dropped or the cabinet has been damaged.
 - f When the television monitor exhibits a distinct change in performance – this indicates a need for service.



- 16 Do not attempt to service this television monitor yourself as opening or removing covers may expose you to dangerous voltage or other hazards. Refer all servicing to qualified service personnel.
- 17 When replacement parts are required, be sure the service technician has used replacement parts specified by the manufacturer that have the same characteristics as the original part. Unauthorized substitutions may result in fire, electric shock, or other hazards.
- 18 Upon completion of any service or repairs to this television monitor, ask the service technician to perform routine safety checks to determine that the television is in safe operating condition.
- 19 **WARNING: To prevent fire or shock hazard, do not expose this appliance to rain or moisture.**
- 20 **CAUTION: TO PREVENT ELECTRIC SHOCK DO NOT USE THIS (POLARIZED) PLUG WITH A RECEPTACLE OR OTHER OUTLET UNLESS THE BLADES CAN BE FULLY INSERTED TO PREVENT BLADE EXPOSURE**

NOTE: This equipment is designed to operate in the U S A , Canada and other countries where the broadcasting system and AC house current is exactly the same as in the U S A and Canada

Important Information Regarding Use of Video Games, Computers, Teletext or Other Fixed Image Displays.

The extended use of fixed image program material can cause a permanent "shadow image" on the picture tube. This background image is viewable on normal programs in the form of a stationary fixed image. This type of irreversible picture tube deterioration can be limited by observing the following steps:

- A Reduce the brightness/contrast setting to a minimum viewing level
- B Do not display the fixed image for extended periods of time
- C Turn the power off when not in actual use

NOTE: The marking or retained image on the picture tube resulting from fixed image use is not an operating defect and as such is not covered by Warranty. This product is not designed to display fixed image patterns for extended periods of time.

Specifications

Power Source:	120V, 60Hz, AC
Video Input Jack:	1V p-p, 75 ohm, phono jack type
Audio Input Jacks:	500 mV rms 47K ohm
S-VHS Input Jack:	S-Video (Y-C) Connector
Video Througout Jack:	phono jack type
Audio Througout Jacks:	phono jack type
To Audio AMP Jacks:	0-2 0V rms 4 7K ohm
Stereo Sound	
Closed Caption Display	

Specifications are subject to change without notice or obligation

Introduction

Congratulations on Your New Purchase

Your new video component features an all solid state chassis which is designed to give you many years of enjoyment. It was thoroughly tested and adjusted at the factory for best performance.

In order for you to take full advantage of your new video component, please read and follow the installation and operating instructions supplied with this product.

Customer's Record

The model and serial number of this product may be found on its back cover. You should note the model and serial number in the space provided and retain this book as a permanent record of your purchase to aid in identification in the event of theft or loss.

Model Number: _____ Serial Number: _____

Table of Contents

Safety Instructions	2	Picture Norm	9
Specifications	3	Timer Features	10
Introduction	4	Sleep Timer	10
Installation	5	Program Timer	11
Monitor Location	5	Set-Up Features	12
Optional External Equipment Connections	5	Menu	12
AC Power Supply Cord	5	Set Time	13
Care and Cleaning	5	<input type="checkbox"/> Mode	14
Location of Controls	6	Instant-On Feature	15
Quick Reference Control Operation	6	Control Panel Lock Feature	15
Control Operation	7	Optional Equipment Connection and Operation .	16
Power Button	7	Stereo Connection (To Audio AMP)	16
Volume (Vol) Buttons	7	S-Video Connection	16
Menu Control (Up/Down) Buttons	7	Video/Audio Input & Throught Out Connections ...	17
Action Button	7	Notes	18
Main Menu (Icons)	8	Troubleshooting Chart	19
Picture Adjustments	9	Power Loss	20
Color, Tint, Brightness, Picture and Sharpness			
Adjustments	9		

Installation

Location

Locate for comfortable viewing. Avoid placing where sunlight or other bright light (including reflections) will fall on the screen.

Use of some types of fluorescent lighting can reduce remote control transmitter range.

Adequate ventilation is essential to prevent internal component failure. Keep away from areas of excessive heat or moisture.

To insure optimum color purity do not position magnetic equipment (motors, fans, other speakers, etc.) nearby.

Optional External Equipment Connections

The Video/Audio connections between components can be made with shielded video and audio cables. For best performance, video cables should utilize 75 ohm coaxial shielded wire. Cables are available from your dealer or electronic supply house.

Before you purchase any cables, be sure you know what type of output and input connectors your various components require. Also determine the length of cable you'll need.

NOTE: Two RCA to BNC adaptors are supplied with the Monitor.



RCA to BNC Adaptor

Power Supply Cord

MAKE SURE PLUG IS INSERTED FULLY INTO RECEPTACLE

This product is equipped with a three-wire grounding type plug – a plug with two blades and a third pin which is round. This plug will only fit into a grounding type outlet.

This is a safety feature. If you are unable to insert the plug into the outlet, contact your electrician to replace your obsolete outlet. **DO NOT DEFEAT THE SAFETY PURPOSE OF THE GROUNDING TYPE PLUG.**



3 Wire Ground Plug

CAUTION: To prevent electric shock, match wide blade of plug to wide slot of AC outlet and fully insert. **DO NOT USE** this (polarized) plug with a receptacle or other outlet unless the blade can be fully inserted to prevent blade exposure.

Care and Cleaning

Picture Tube (Turn set off)

Use a mild soap solution or window cleaner and a clean cloth. **DO NOT USE ABRASIVE CLEANERS.** Avoid excessive moisture and wipe dry.

Plastic Cabinets

Wipe the cabinet with a soft cloth dampened with water or a mild detergent solution and wipe dry with a soft clean cloth. Avoid excessive moisture. Do not use benzene, thinners or other petroleum based cleaners.

Wood Cabinets

When dusting or polishing the cabinet, use a clean soft cloth and stroke straight with the grain. An occasional coat of furniture polish will help preserve the finish. Do not use benzene, thinners or other petroleum based cleaners. Do not place objects made of plastic or rubber directly on top of the cabinet. A chemical reaction could result causing permanent marring of the finish.

Location of Controls

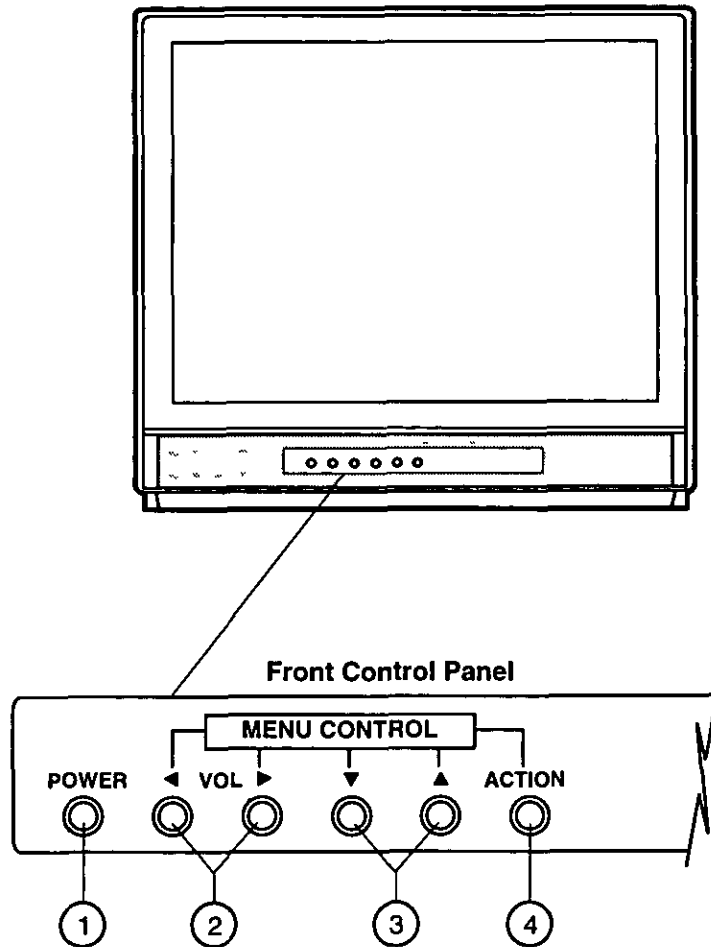

Quick Reference Control Operation

- ① **Power Button** – Press to turn ON or OFF
- ② **Vol (Volume) Buttons** – Press to adjust Sound Level Press to adjust Video Menus, and select operating features when menus are displayed
- ③ **Menu Control UP/DOWN Buttons**– Press to select desired features when menus are displayed
- ④ **Action Button** – Press to display Main Menu and access On-Screen feature and Adjustment Menus

Control Operation

Power Button – Press the POWER button to turn ON Press again to turn OFF

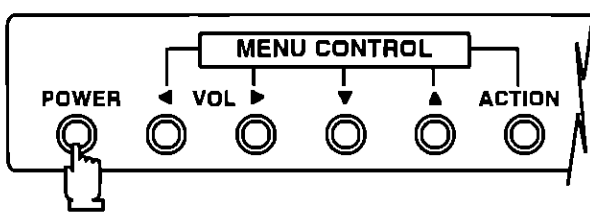

Menu Control (UP/DOWN) Buttons

Press the UP/DOWN buttons to select or adjust On Screen Menus

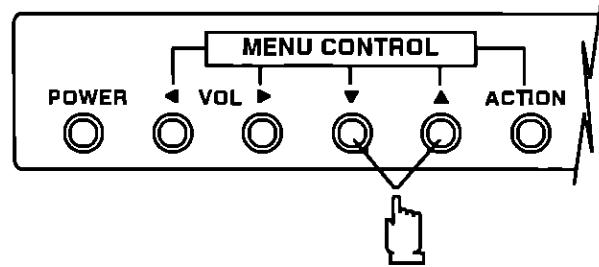

Volume Buttons – Press the VOLUME (VOL) LEFT or RIGHT button for desired listening level (while On Screen Menus are not displayed)

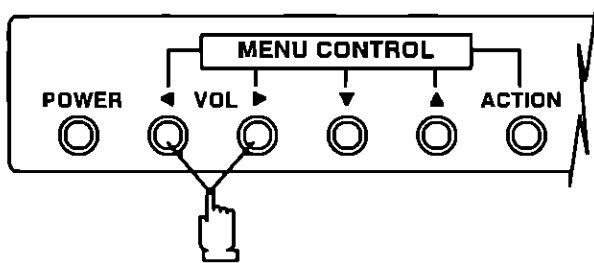

Action Button – Press the ACTION button to display or exit Menus

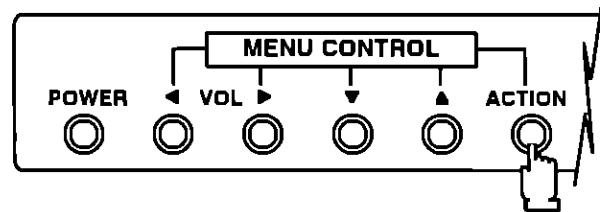

Main Menu (Icons)

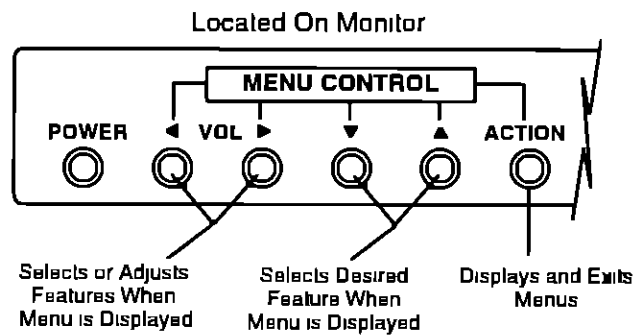
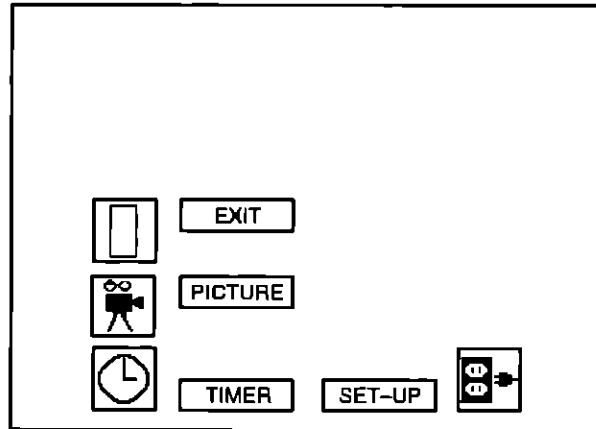

- 1 Press the ACTION button to display the Main Menu with Icons
- 2 Press the UP/DOWN and the VOL LEFT/RIGHT buttons to select the desired Icon when the Main Menu is displayed (selected Icon will be indicated in Red)
- 3 Press the VOL buttons for left and right movement and the UP/DOWN buttons for up or down movement
- 4 To exit the Main Menu first select the EXIT Icon, then press the ACTION button

Picture Adjustments

- Color
- Tint
- Brightness
- Picture
- Sharpness
- Picture Norm

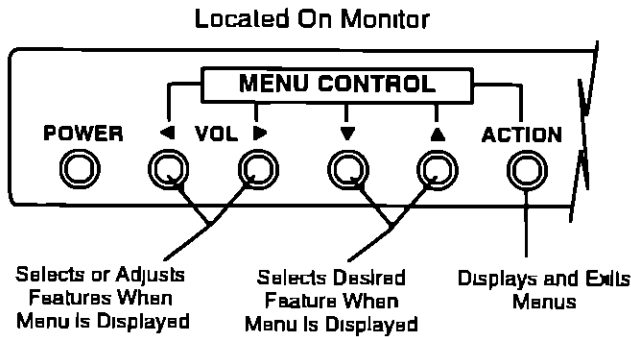

Color, Tint, Brightness, Picture and Sharpness Adjustments

- 1 Press the ACTION button to display the Main Menu
- 2 Press the DOWN button to select the Picture Icon
- 3 Press the ACTION button to display the Picture Adjustment Menu

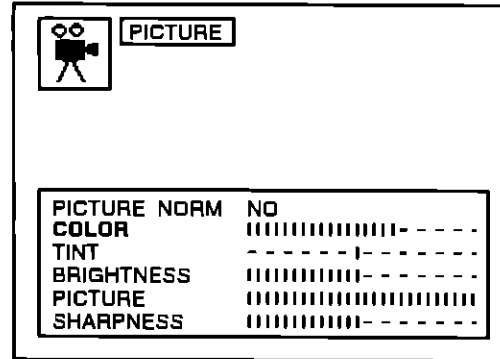

- 4 Press the UP/DOWN button to select the desired Picture Adjustment (Color, Tint, Brightness, Picture or Sharpness)
- 5 Press the VOL LEFT/RIGHT button to adjust your selection
- 6 Repeat steps 4 and 5 for the remaining Picture Adjustments
- 7 Press ACTION button twice to exit menus

Picture Norm – This feature is used to reset Color, Tint, Brightness, Picture and Sharpness back to a factory preset level

- 1 Press the ACTION button to display the Main Menu
- 2 Press the DOWN button to select the Picture Icon
- 3 Press the ACTION button to display the Picture Adjustment Menu

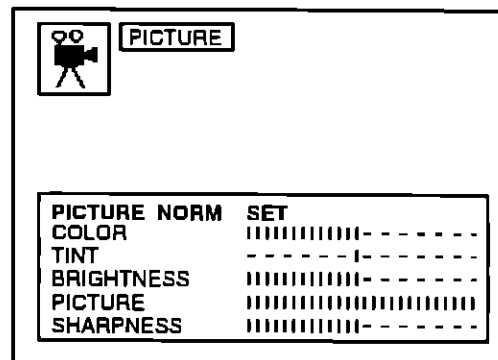

- 4 Press the VOL LEFT/RIGHT button to select "SET" to Normalize Color, Tint, Brightness, Picture and Sharpness
- 5 Press ACTION button twice to exit menus

Helpful Hints:

- COLOR** – adjust for desired color intensity
- TINT** – adjust for natural flesh tones
- BRIGHTNESS** – adjust so dark areas of picture slightly become black for a crisp detail
- PICTURE** – adjust the white areas of the picture as desired
- SHARPNESS** – adjust for best clarity of outline detail

Timer Features

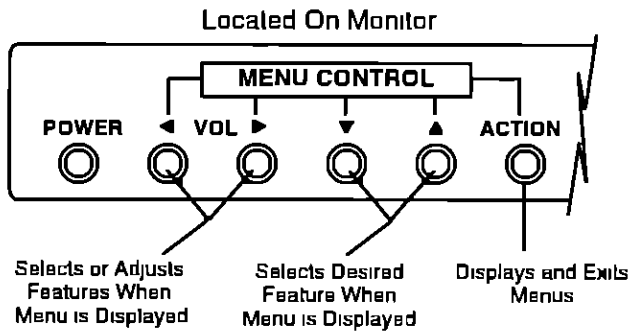

Sleep Timer – This feature is used for automatic turn off in 30, 60, or 90 minutes

NOTE. Display will flash 3, 2, and 1 to indicate the last three remaining minutes prior to turn off

- 1 Press the ACTION button to display the Main Menu
- 2 Press the DOWN button to select the Timer Icon
- 3 Press the ACTION button to display the Timer Control Menu

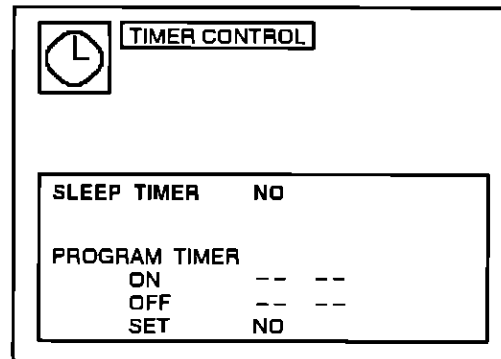

- 4 Press the VOL RIGHT button to select NO, 30, 60, or 90 minutes
- 5 Press ACTION button twice to exit menus

NOTE: To deactivate Sleep Timer repeat steps 1 through 4. In step 4 select "NO" instead of minutes

Timer Features (cont.)

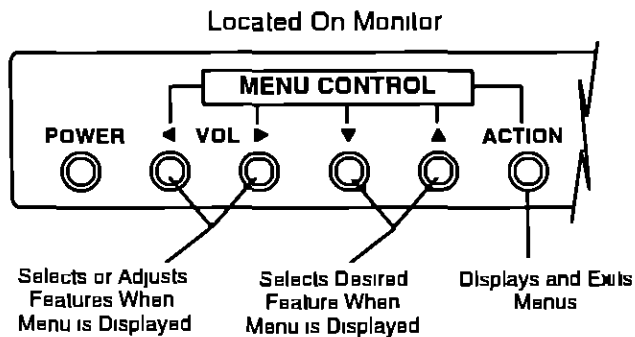

Program Timer – This feature is capable of turning the TV on and off at a predetermined time (one day or everyday)

NOTE: The clock must be set for this feature to operate (Refer to the Set-Up Menu to set time)

- 1 Press the **ACTION** button to display the Main Menu
- 2 Press the **DOWN** button to select the Timer Icon
- 3 Press the **ACTION** button to display the Timer Control Menu

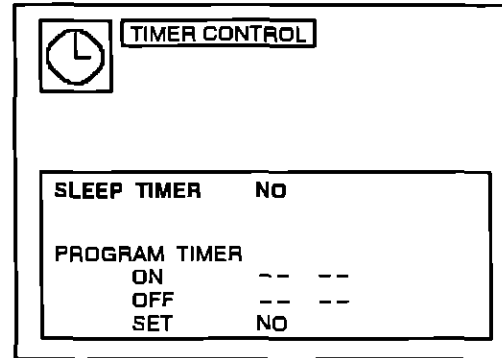

- 4 Press the **DOWN** button to select "ON" (time)
 - 5 Press the **VOL LEFT/RIGHT** button repeatedly to set hours (set AM/PM accordingly)
 - 6 Press the **DOWN** button to select the minutes position
 - 7 Press the **VOL LEFT/RIGHT** button repeatedly to set minutes
 - 8 Press the **DOWN** button to select "OFF" (time)
 - 9 Repeat steps 5 through 7 for setting "OFF" (time)
 - 10 Press the **DOWN** button to select "SET"
 - 11 Press the **VOL RIGHT** button to select
 - NO – not activated
 - ONE DAY – activated
 - EVERY DAY – activated
- NOTE:** To deactivate Program Timer select "NO" in step 11
- 12 Press **ACTION** button twice to exit menus

Set-Up Features

- Menu
 - Set Time
 - CC (Closed Caption) Mode
- CC (Closed Caption) on Mute
This feature is not available in this model

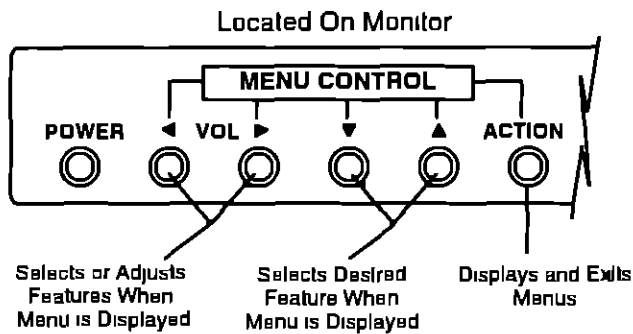

Menu – The Main Menu can be displayed in two formats Icon with Text or Icon without Text for those familiar with the Icon system

1. Press the ACTION button to display the Main Menu
2. Press the DOWN and VOL RIGHT buttons to select the Set-Up Icon
3. Press the ACTION button to display the Set-Up Menu

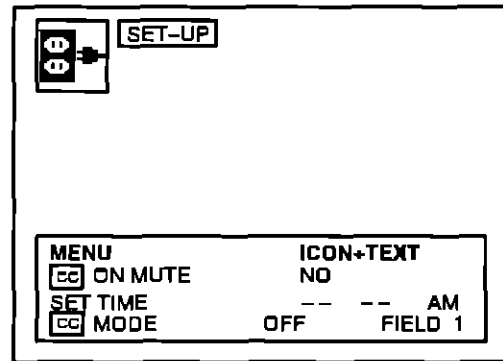

4. Press the VOL LEFT/RIGHT button to select ICON with TEXT or ICON only.
5. Press ACTION button twice to exit menus

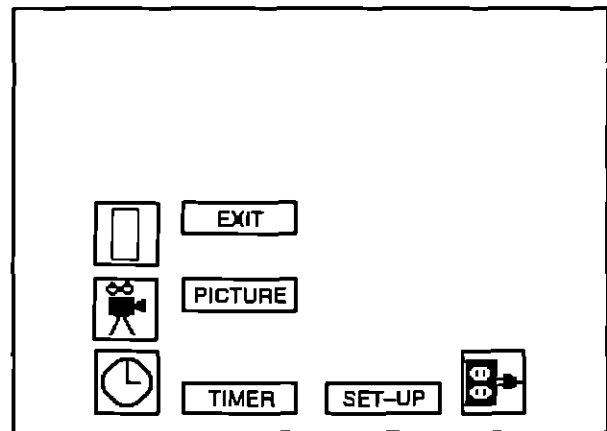

Icon with Text

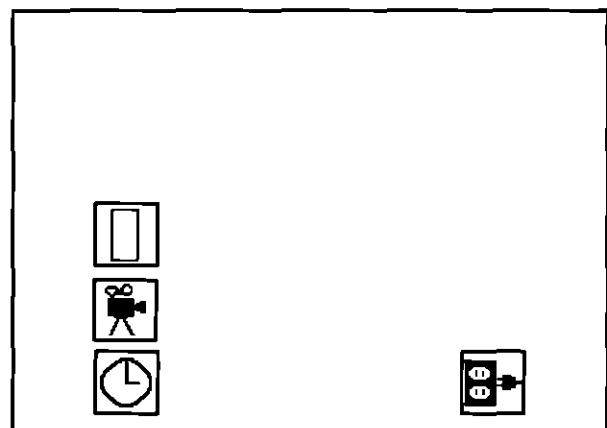

Icon (Only)

Set-Up Features (cont.)

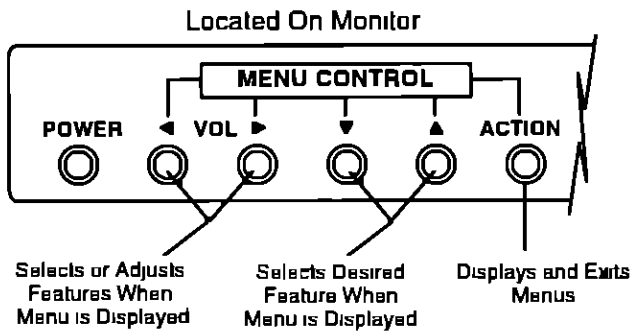

Set Time – Clock (when set) will display on screen at initial “Turn On”

- 1 Press the ACTION button to display the Main Menu
- 2 Press the DOWN and VOL RIGHT buttons to select the Set-Up Icon
- 3 Press the ACTION button to display the Set-Up Menu

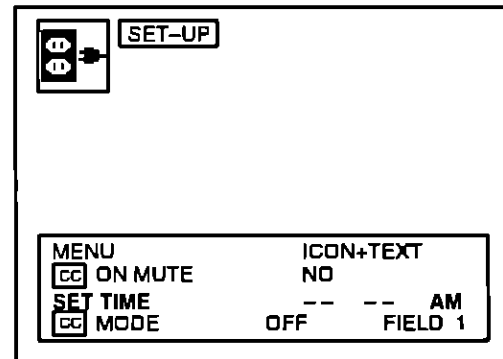

- 4 Press the DOWN button to select “SET TIME”
- 5 Press the VOL LEFT/RIGHT button to set hours (set AM/PM accordingly)
- 6 Press the DOWN button to select minutes position
- 7 Press the VOL LEFT/RIGHT button repeatedly to set minutes
- 8 Press ACTION button twice to exit menus

Set-Up Features (cont.)

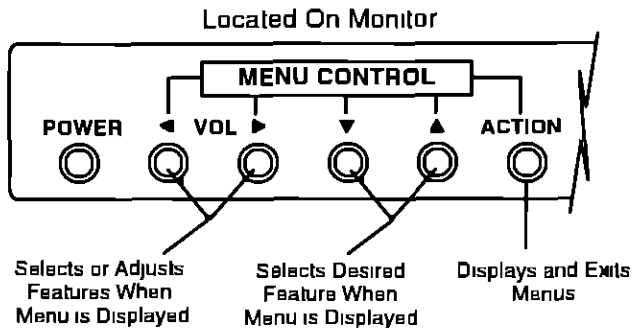

CC Mode

This Receiver has a built-in decoder that provides a visual depiction of the audio portion of a television program in the form of written words across the screen (white or colored letters on a black background) It allows the viewer to read the dialogue of a television program or other information

- 1 Press the **ACTION** button to display the Main Menu
- 2 Press the **DOWN** and **VOL RIGHT** buttons to select the Set-Up Icon
- 3 Press the **ACTION** button to display the Set-Up Menu

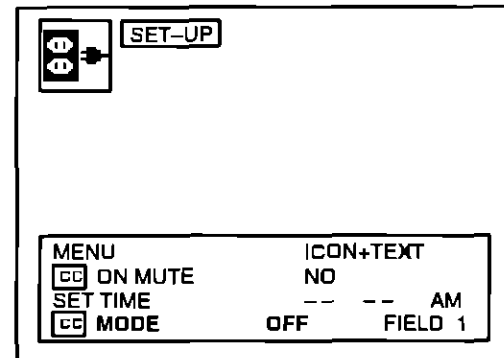

- 4 Press the **DOWN** button to select "CC MODE"
- 5 Press the **VOL RIGHT** button to select OFF, CAP C1, TEXT C1, CAP C2, or TEXT C2
 - **CAPTION OFF** – Recommended mode when you do not wish to view Closed Caption
 - **CAPTION C1** – For video related information that can be displayed (up to four (4) lines of script strategically placed on the television screen so that it does not obstruct relevant parts of the picture) Script can be in any language
 - **TEXT C1** – Blanks out a large portion of the picture on the television screen, and displays program guide or any other information currently being transmitted
 - **CAPTION C2** – Another mode used for video related information that can be displayed (up to four (4) lines of script strategically placed on the television screen so that it does not obstruct relevant parts of the picture)
 - **TEXT C2** – Another mode which displays information and blanks out a large portion of the picture on the television screen
- 6 Press the **DOWN** button to select the Field position
- 7 Press the **VOL LEFT/RIGHT** button to select "FIELD 1" or "FIELD 2"
- 8 Press **ACTION** button twice to exit menus

Helpful Hints:

- Closed Caption information may be transmitted on either or both Caption Fields
- Most Closed Caption information is transmitted on Field 1 in Cap C1 Mode
- De-select Text mode if large portion of the picture is blanked out

Instant-On Feature

This Monitor has an Instant-On feature which automatically turns the unit ON when AC power is supplied

This feature initiates the Monitor to turn ON automatically when using it with other equipment connected to a main power supply switch (Such as AC power strip or when plugged directly into the back of a computer)

Once initial power has been supplied and the Monitor turns ON, the POWER switch located on the front of the Monitor may be used to turn the Monitor OFF and ON as desired

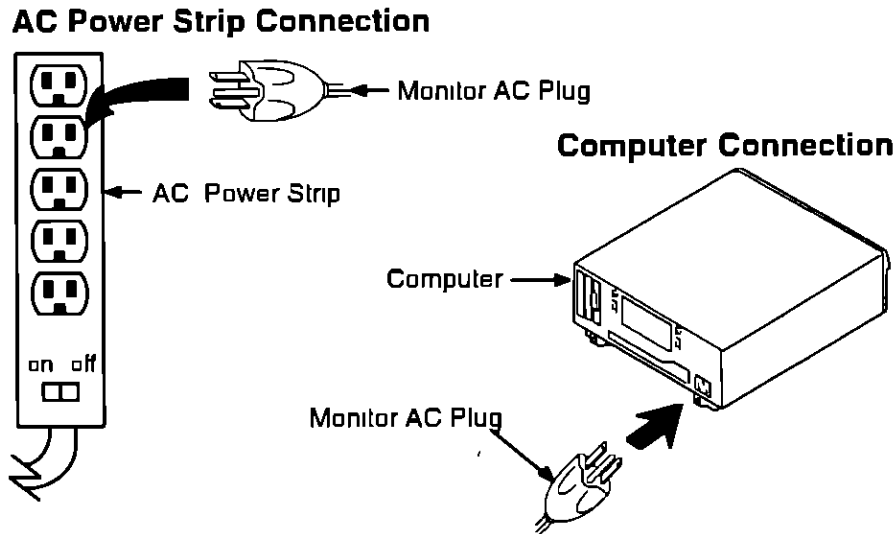

Procedure for Instant-On feature

With the Monitor turned ON, press the ACTION and VOL LEFT buttons simultaneously, then press the ACTION and DOWN buttons simultaneously This will activate the Instant-On feature, to deactivate repeat procedure

NOTE. There will be no On-Screen display

To confirm if the Instant-On feature is activated Turn the Monitor OFF, then unplug it and plug it back in The Monitor should turn on automatically

Control Panel Lock Feature

Procedure for Control Panel Lock feature

With the Monitor turned ON, press the ACTION and VOL RIGHT buttons simultaneously, then press the ACTION and UP buttons simultaneously This will activate the Keyboard Lock feature, to deactivate repeat procedure

NOTE: There will be no On Screen display

To confirm if the Control Panel Lock feature is activated, press any button other than the POWER button (the Power button is never disabled)

Optional Equipment Connection and Operation

To Audio AMP Connection (Stereo)

Connect to an external audio amp auxiliary input for monitoring sound through a stereo system

NOTE: "TO AUDIO AMP" terminals cannot be used for external speakers

Operation:

- 1 Connect an Video/Audio source to the Video/Audio Input jacks on back of the monitor
- 2 Connect a RCA phono jack from an external audio amp to L&R "TO AUDIO AMP" jacks, on back of monitor
- 3 Adjust volume of Monitor to desired listening level (use monitor volume left/right buttons)
- 4 Adjust volume of audio amp to desired listening level (use audio amp volume control)

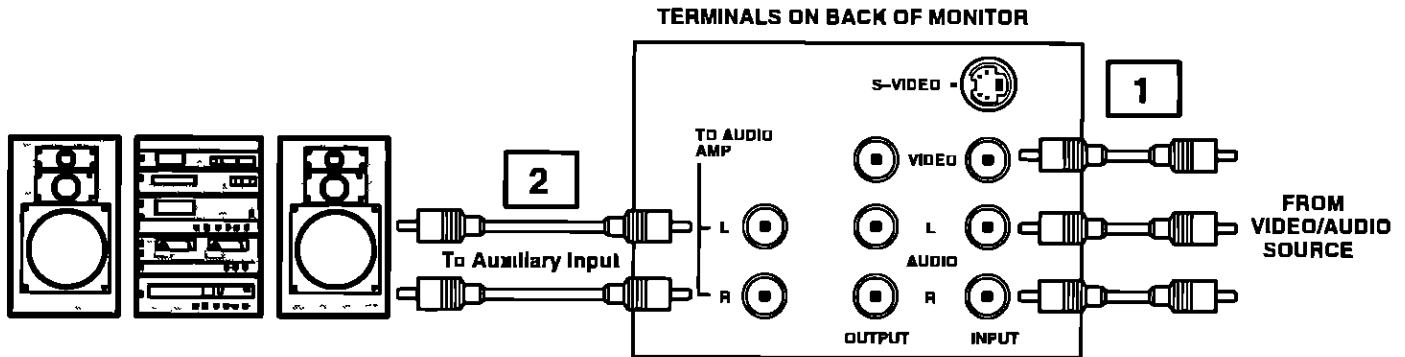

S-Video Connection

Operation:

- 1 Connect S-Video (Yc) connector to S-Video Terminals
- 2 Make connections to L and R Input Audio jacks
- 3 Operate optional equipment (VCR-VDP) as instructed in Optional Equipment manual

NOTE: Connection of optional S-VIDEO jack automatically disconnects the Normal Video Input jack

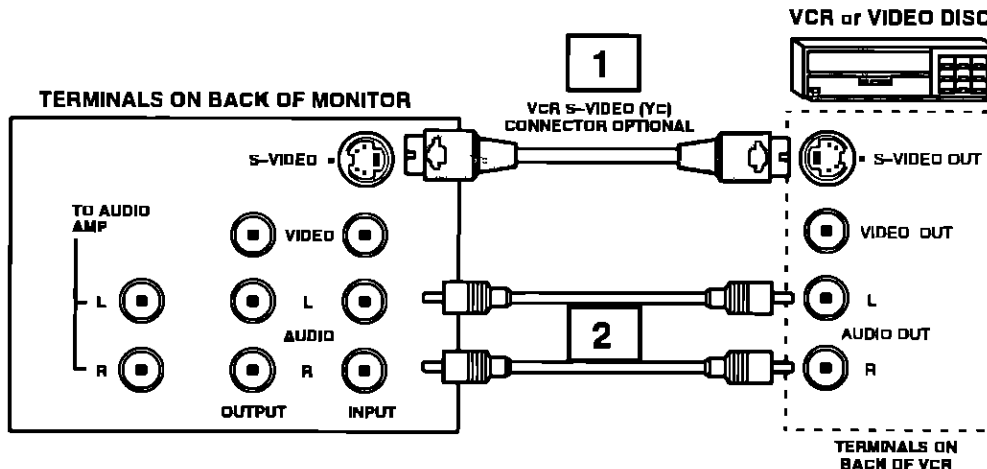

Optional Equipment Connection and Operation (cont.)

Video/Audio Input & Through Out Connections

The input and output terminals located on the back of the Monitor directly pass the input signals through the output terminals, so you may monitor or record the external Video/Audio information

NOTE: INPUT and OUTPUT terminals will operate whether the Monitor is ON or OFF

Operation

- 1 Connect an external Video/Audio source to the video/audio input terminals on back of Monitor
- 2 Connect a VCR or another Monitor to the Video/Audio output terminals on back of the Monitor
- 3 Operate optional equipment (VCR-VDP) as instructed in Optional Equipment manual



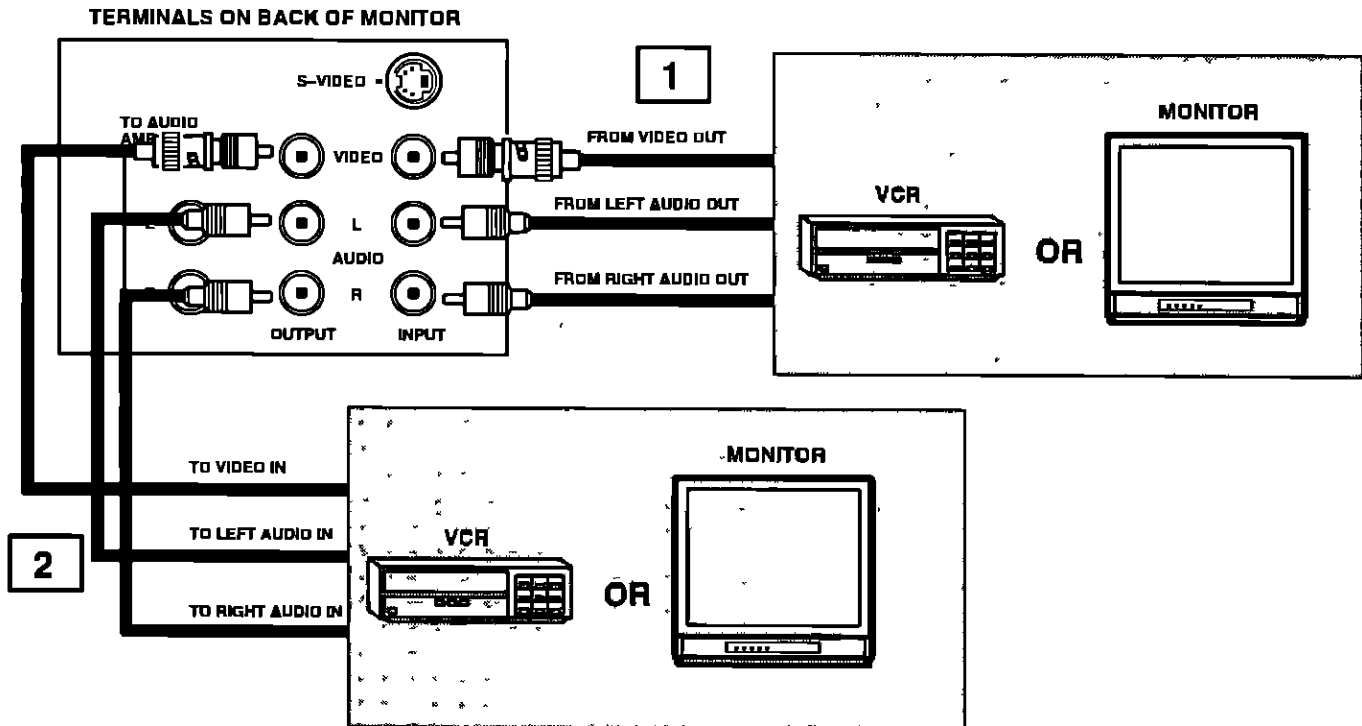











NOTE: Two RCA to BNC adaptors are supplied with the Monitor if needed



NOTE:

Troubleshooting Chart

Before you call for service, determine the symptoms and make a few simple checks shown below

Symptoms		Check
Picture	Sound	
 SNOWY PICTURE	 NOISY SOUND	- INPUT CONNECTORS SEATED PROPERLY - EQUIPMENT CONNECTED TO INPUT CONNECTIONS - ANTENNA LOCATION AND/OR CONNECTION (IF APPLICABLE)
 INTERFERENCE	 NOISY SOUND	- ELECTRICAL APPLIANCES, LIGHTS, CARS AND TRUCKS - DIATHERMY AND OTHER MEDICAL EQUIPMENT - VIDEO INPUT CONNECTOR SEATED PROPERLY
 NORMAL PICTURE	 NO SOUND	- VOLUME CONTROL SETTING - TV SPEAKERS (IF APPLICABLE) IN THE OFF MODE - AUDIO INPUT CONNECTOR SEATED PROPERLY - TRY ANOTHER CHANNEL (IF APPLICABLE)
 NO PICTURE	 NO SOUND	- THAT AC POWER LINE IS PLUGGED INTO AC OUTLET - BRIGHTNESS AND AUDIO CONTROLS SET PROPERLY - VIDEO AND AUDIO INPUT CONNECTORS SEATED PROPERLY - TRY ANOTHER CHANNEL (IF APPLICABLE)
 NO COLOR	 NORMAL SOUND	- COLOR CONTROL SETTINGS - TRY ANOTHER CHANNEL (IF APPLICABLE)
 BLUE PICTURE	 NO SOUND	- MONITOR WITH NO VIDEO SIGNAL (IF APPLICABLE)
 BLACK BOX IN PICTURE	 SOUND	- CC (CLOSED CAPTION) IN TEXT MODE - SELECT CLOSED CAPTION OFF MODE TO ELIMINATE BLACK BOX

Should this unit turn ON momentarily and then turn OFF, or fail to operate, unplug the AC cord and contact your Authorized Servicer for repairs

Power Loss

Prolonged power interruption causes the following features to reset to their factory preset state.

FEATURE POWER CLOCK	FACTORY PRESET STATE OFF NOT SET	FEATURE SLEEP TIMER TIMER	FACTORY PRESET STATE OFF OFF
---------------------------	--	---------------------------------	------------------------------------

Panasonic®

BROADCAST AND TELEVISION SYSTEMS

PANASONIC BROADCAST AND TELEVISION SYSTEMS COMPANY

Division of Matsushita Electric Corporation of America

Executive Office

One Panasonic Way, Secaucus, New Jersey, 07094 (201) 348-7000

BTS Division Executive Office, One Panasonic Way, Secaucus, New Jersey 07094 (201) 348-7000

GSA Order Department, One Panasonic Way, Secaucus, New Jersey 07094 (201) 348-7860

Eastern Regional Sales Office, Panasonic BTS, 43 Hartz Way, Secaucus, New Jersey 07094 (201) 348-7620

Midwest Regional Sales Office, Panasonic BTS, 1707 North Randall Road, Elgin, Illinois 60123 (847) 468-5200

Southeast Regional Sales Office, Panasonic BTS, 1854 Shackelford Court, Suite 115, Norcross, Georgia 30093 (404) 717-6841

Southwest Regional Sales Office, Panasonic BTS, 4500 Amon Carter Boulevard, Fort Worth, Texas 76155 (817) 685-1117

Western Regional Sales Office, Panasonic BTS, 6550 Katella Avenue, Cypress, California 90630 (714) 373-7275

Northwest Regional Sales Office, Panasonic BTS, The AGC Building, 1200 Westlake Avenue North, Suite 508, Seattle, WA 98109 (206) 285-8883

MATSUSHITA ELECTRIC OF CANADA LIMITED

5770 Ambler Drive, Mississauga, Ontario, L4W 2T3

PANASONIC SALES COMPANY

San Gabriel Industrial Park, 65th Infantry Ave, KM 9 5, Carolina, Puerto Rico 00630